

Thank you for purchasing this Esco Biological Safety Cabinet. Please read this manual thoroughly to familiarize yourself with the many unique features and exciting innovations we have built into your new equipment. Esco provides many other resources at our website, www.escoglobal.com, to complement this manual and help you enjoy many years of productive and safe use of your Esco products.



User Manual

**For Technical Service, contact
North America**

*Esco Technologies, Inc.
2940 Turnpike Drive, Units 15-16 • Hatboro, PA 19040, USA
Toll-Free USA and Canada 1-877-479-3726
Tel 215-441-9661 • Fax 215-441-9660
us.escoglobal.com • usa@escoglobal.com*

Rest of World

*Esco Micro Pte. Ltd.
21 Changi South Street 1 • Singapore 486 777
Tel +65 6542 0833 • Fax +65 6542 6920
www.escoglobal.com • mail@escoglobal.com*

Ascent•MAX.

Ductless Fume Hood

Copyright Information

© Copyright 2011 Esco Micro Pte. Ltd. All rights reserved.

The information contained in this manual and the accompanying product is copyrighted and all rights are reserved by Esco.

Esco reserves the right to make periodic minor design changes without obligation to notify any person or entity of such change.

Sentinel® and AscentMax® are registered trademarks of Esco.

“Material in this manual is provided for informational purposes only. The contents and the product described in this manual (including any appendix, addendum, attachment or inclusion), are subject to change without notice. Esco makes no representations or warranties as to the accuracy of the information contained in this manual. In no event shall Esco be held liable for any damages, direct or consequential, arising out of or related to the use of this manual.”

Table of Contents

i	Table of Contents
iii	Warranty Terms and Conditions
v	Introduction
v	1. Products Covered
v	2. Safety Warning
v	3. Limitation of Liability
vi	4. European Union Directives on WEEE and RoHS
vii	Declaration of Conformity

1 Chapter 1 – Product Information

1	1.1 Quick View
1	1.1.1 ADC- _B_ / ADC- _D_ Series Quick View
2	1.1.2 ADC- _C_ / ADC- _E_ Series Quick View
3	1.2 Filtracheck

5 Chapter 2 – Control System

5	2.1 Sentinel Control System
6	2.2 Menu Options
7	2.2.1 Settings
7	2.2.2 Calibration
8	2.2.3 Admin
9	2.2.4 Setting Mode
10	2.3 Alarm and Warnings

11 Chapter 3 - Basic Hood Operation

11	3.1 Sash Window Operation
11	3.1.1 Sash Window State
11	3.1.2 Operating Motorized Sash Window
12	3.1.3 Using Sash Window
12	3.2 Starting and Shutting Down the Ductless Fume Hood
12	3.2.1 Turning on the Hood
12	3.2.2 Turning off the Hood
12	3.3 Operating the Ductless Fume Hood
12	3.3.1 Working in the Hood
13	3.3.2 Working Ergonomics

15 Chapter 4 – Service and Maintenance

15	4.1 Scheduled Maintenance
16	4.2 Maintenance/Service Log

Warranty Terms and Conditions

Esco products come with either a 1, 2 or 3 year limited warranty, depending on the product purchased, beginning on the date of shipment from any Esco international warehousing location. To determine which warranty applies to your product, refer to the appendix below.

Esco's limited warranty covers defects in materials and workmanship. Esco's liability under this limited warranty shall be, at our option, to repair or replace any defective parts of the equipment, provided if proven to the satisfaction of Esco that these parts were defective at the time of being sold, and that all defective parts shall be returned, properly identified with a Return Authorization.

This limited warranty covers parts only, and not transportation/insurance charges.

This limited warranty does not cover:

- Freight or installation (inside delivery handling) damage. If your product was damaged in transit, you must file a claim directly with the freight carrier.
- Products with missing or defaced serial numbers.
- Products for which Esco has not received payment.
- Problems that result from:
 - External causes such as accident, abuse, misuse, problems with electrical power, improper operating environmental conditions.
 - Servicing not authorized by Esco.
 - Usage that is not in accordance with product instructions.
 - Failure to follow the product instructions.
 - Failure to perform preventive maintenance.
 - Problems caused by using accessories, parts, or components not supplied by Esco.
 - Damage by fire, floods, or acts of God.
 - Customer modifications to the product
- Consumables such as filters (HEPA, ULPA, carbon, pre-filters) and fluorescent / UV bulbs.
- Esco is not liable for any damage incurred on the objects used on or stored in Esco equipment. If the objects are highly valuable, user is advised to have in place independent external preventive measures such as connection to a centralized alarm system.

Factory installed, customer specified equipment or accessories are warranted only to the extent guaranteed by the original manufacturer. The customer agrees that in relation to these products purchased through Esco, our limited warranty shall not apply and the original manufacturer's warranty shall be the sole warranty in respect of these products. The customer shall utilize that warranty for the support of such products and in any event not look to Esco for such warranty support.

Esco encourages all users to register their equipment online at www.escoglobal.com/warranty or complete the warranty registration form included with each product.

ALL EXPRESS AND IMPLIED WARRANTIES FOR THE PRODUCT, INCLUDING BUT NOT LIMITED TO ANY IMPLIED WARRANTIES AND CONDITIONS OF MERCHANTABILITY AND FITNESS FOR A PARTICULAR PURPOSE ARE LIMITED IN TIME TO THE TERM OF THIS LIMITED WARRANTY. NO WARRANTIES, WHETHER EXPRESS OR IMPLIED, WILL APPLY AFTER THE LIMITED WARRANTY PERIOD HAS EXPIRED. ESCO DOES NOT ACCEPT LIABILITY BEYOND THE REMEDIES PROVIDED FOR IN THIS LIMITED WARRANTY OR FOR SPECIAL, INDIRECT, CONSEQUENTIAL OR INCIDENTAL DAMAGES, INCLUDING, WITHOUT LIMITATION, ANY LIABILITY FOR THIRD-PARTY CLAIMS AGAINST YOU FOR DAMAGES, FOR PRODUCTS NOT BEING AVAILABLE FOR USE, OR FOR LOST WORK. ESCO'S LIABILITY WILL BE NO MORE THAN THE AMOUNT YOU PAID FOR THE PRODUCT THAT IS THE SUBJECT OF A CLAIM. THIS IS THE MAXIMUM AMOUNT FOR WHICH ESCO IS RESPONSIBLE.

These Terms and Conditions shall be governed by and construed in accordance with the laws of Singapore and shall be subject to the exclusive jurisdiction of the courts of Singapore.

Technical Support, Warranty Service Contacts

USA: 1-877-479-3726

Singapore: +65 65420833

Global Email Helpdesk: support@escoglobal.com

Visit <http://www.escoglobal.com/> to talk to a Live Support Representative

Distributors are encouraged to visit the Distributor Intranet for self-help materials.

Product Appendix, Warranty Listings

Biological Safety Cabinets, Laminar Flow Cabinets, HEPA-Filtered Cabinets (except Streamline brand)	The warranty periods for BSC may vary by country. Contact your local distributor for specific warranty details.
Laboratory Fume Hoods	1 year limited.
Ductless Fume Hoods	3 years limited for Ascent Opti's, 5 years for Ascent Max's.
Cleanroom Equipment	1 year limited.
Laboratory Ovens and Incubators	1 year limited.
CO ₂ Incubators	2 years limited.
Containment/Pharma Products	2 years limited.
Ultralow Temperature Freezer	3 years limited. 60 months on Compressor.

The warranty period starts two months from the date your equipment is shipped from Esco facility for international distributors. This allows shipping time so the warranty will go into effect at approximately the same time the equipment is delivered to the user. The warranty protection extends to any subsequent owner during the warranty period. Distributors who stock Esco equipment are allowed an additional four months for delivery and installation, providing the product is registered with Esco. User can register product online at www.escoglobal.com/warranty or complete the warranty registration form included with each product.

Policy updated on 12th Apr 2011 (This limited warranty policy does not apply to products purchased before 12th Apr 2011)

Introduction

1. Products Covered

Esco Ductless Fume Hood – Ascent Max (ADC Series)					
Electrical Rating	0.6 meters 2 feet	0.9 meters 3 feet	1.2 meters 4 feet	1.5 meters 5 feet	1.8 meters 6 feet
220-240 V AC, 50Hz, 1Φ	ADC-2B1	ADC-3B1 ADC-3C1 ADC-3D1 ADC-3E1	ADC-4B1 ADC-4C1 ADC-4D1 ADC-4E1	ADC-5B1 ADC-5C1 ADC-5D1 ADC-5E1	ADC-6B1 ADC-6C1 ADC-6D1
110-120 V AC, 50Hz, 1Φ	ADC-2B2	ADC-3B2 ADC-3C2 ADC-3D2 ADC-3E2	ADC-4B2 ADC-4C2 ADC-4D2 ADC-4E2	ADC-5B2 ADC-5C2 ADC-5D2 ADC-5E2	ADC-6B2 ADC-6C2 ADC-6D2
220-240 V AC, 60Hz, 1Φ	ADC-2B3	ADC-3B3 ADC-3C3 ADC-3D3 ADC-3E3	ADC-4B3 ADC-4C3 ADC-4D3 ADC-4E3	ADC-5B3 ADC-5C3 ADC-5D3 ADC-5E3	ADC-6B3 ADC-6C3 ADC-6D3

2. Safety Warning

- Anyone working with, on or around this equipment should read this manual. Failure to read, understand and follow the instructions given in this documentation may result in damage to the unit, injury to operating personnel, and / or poor equipment performance.
- Any internal adjustment, modification or maintenance to this equipment must be undertaken by qualified service personnel.
- The use of any hazardous materials in this equipment must be monitored by an industrial hygienist, safety officer or some other suitably qualified individual.
- Before you process, you should thoroughly understand the installation procedures and take note of the environmental / electrical requirements.
- In this manual, important safety related points will be marked with the symbol. 
- If the equipment is used in a manner not specified by this manual, the protection provided by this equipment may be impaired.

3. Limitation of Liability

The disposal and / or emission of substances used in connection with this equipment may be governed by various local regulations. Familiarization and compliance with any such regulations are the sole responsibility of the users. Esco's liability is limited with respect to user compliance with such regulations.

4. European Union Directive on WEEE and RoHS

The European Union has issued two directives:

- **Directive 2002/96/EC on Waste Electrical and Electronic Equipment (WEEE)**

This product is required to comply with the European Union's Waste Electrical & Electronic Equipment (WEEE) Directive 2002/96/EC. It is marked with the following symbol:

Esco sells products through distributors throughout Europe. Contact your local Esco distributor for recycling/disposal.

- **Directive 2002/95/EC on Restriction on the use of Hazardous Substances (RoHS)**

With respect to the directive on RoHS, please note that this hood falls under category 8 (medical devices) and category 9 (monitoring and control instruments) and is therefore exempted from requirement to comply with the provisions of this directive.



Declaration of Conformation

In accordance to EN ISO/IEC 17050-1:2010

We, Esco Micro Pte. Ltd.
of 21 Changi South Street 1
Singapore, 486777
Tel: +65 6542 0833
Fax: +65 6542 6920

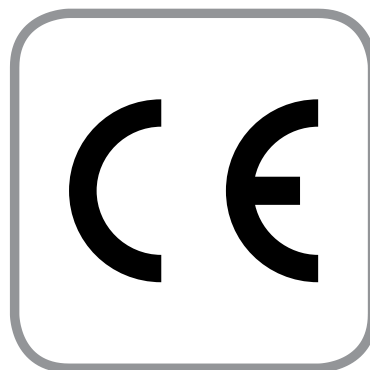

declare on our sole responsibility that the product:

Category : Ductless Fume Hoods
Brand : Ascent Max
Model : ADC-2B1, ADC-3B1, ADC-4B1, ADC-5B1, ADC-6B1
ADC-3C1, ADC-4C1, ADC-5C1, ADC-6C1
ADC-3D1, ADC-4D1, ADC-5D1, ADC-6D1
ADC-3E1, ADC-4E1, ADC-5E1

in accordance with the following directives:

2006/95/EEC : The Low Voltage Directive and its amending directives
92/31/EEC : The Electromagnetic Compatibility Directive and its amending directives

has been designed to comply with the requirement of the following Harmonized Standard:

Low Voltage : EN 61010-1:2010
EMC : EN 61326-1:2006 Class B

More information may be obtained from Esco's authorized distributors located within the European Union. A list of these parties and their contact information is available on request from Esco.

A handwritten signature in black ink, appearing to read 'XQ Lin', is positioned above a horizontal line.

XQ Lin
Group CEO, ESCO

This Declaration of Conformity is only applicable for 230V AC 50Hz units

Chapter 1 - Product Information

1.1 Quick View

1.1.1 ADC-_B_ / ADC-_D_ Series Quick View

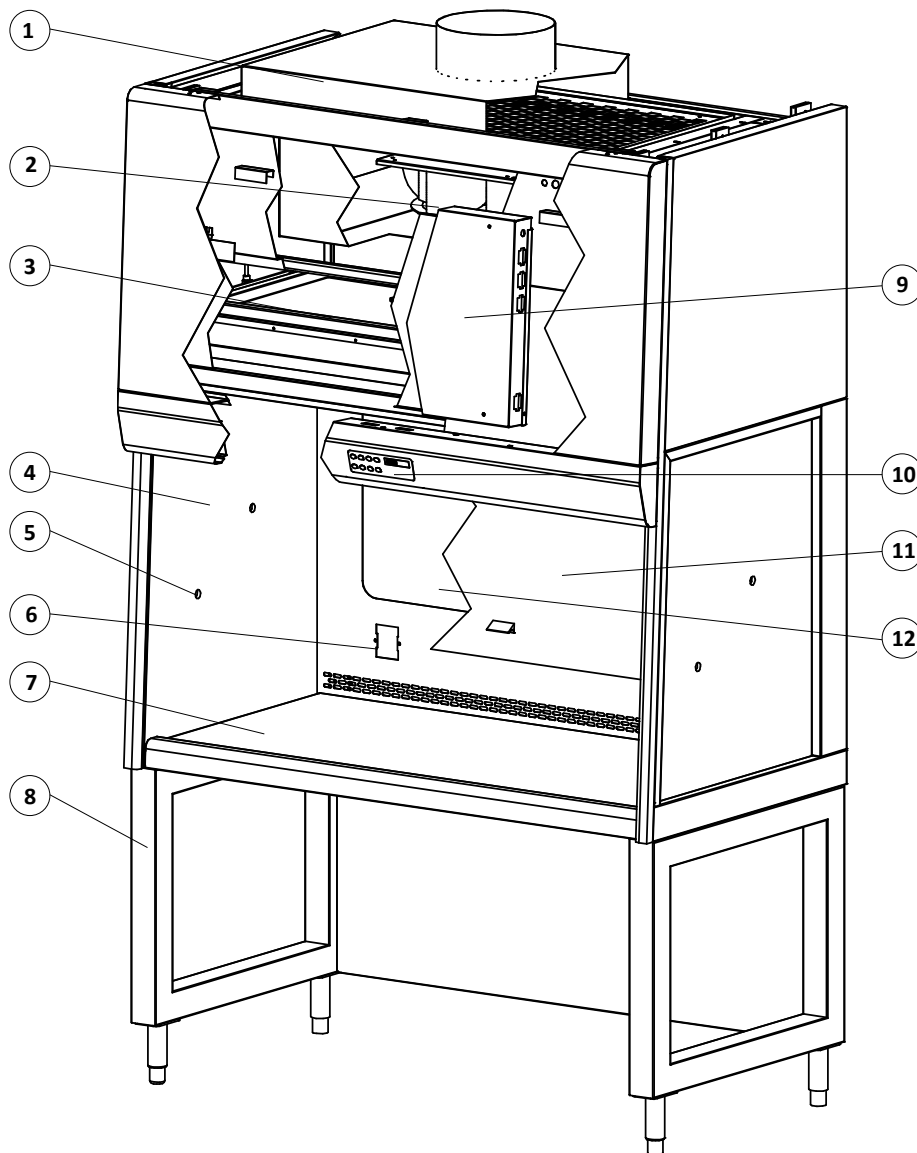

- | | |
|---|--|
| 1. Exhaust Collar (optional) | 7. Stainless Steel Worktop |
| 2. Blower | 8. Support Stand (optional) |
| 3. Carbon Filter(s) | 9. Electrical/Electronic Panel |
| 4. Tempered Glass Side Wall | 10. Esco Sentinel Microprocessor Control |
| 5. Service Fixture Provision (optional) | 11. Tempered Glass Sliding Sash Window |
| 6. Electric Outlet Provision (optional) | 12. Tempered Glass Back Wall (D Series only) |

1.1.2 ADC-C_ / ADC-E_ Series Quick View

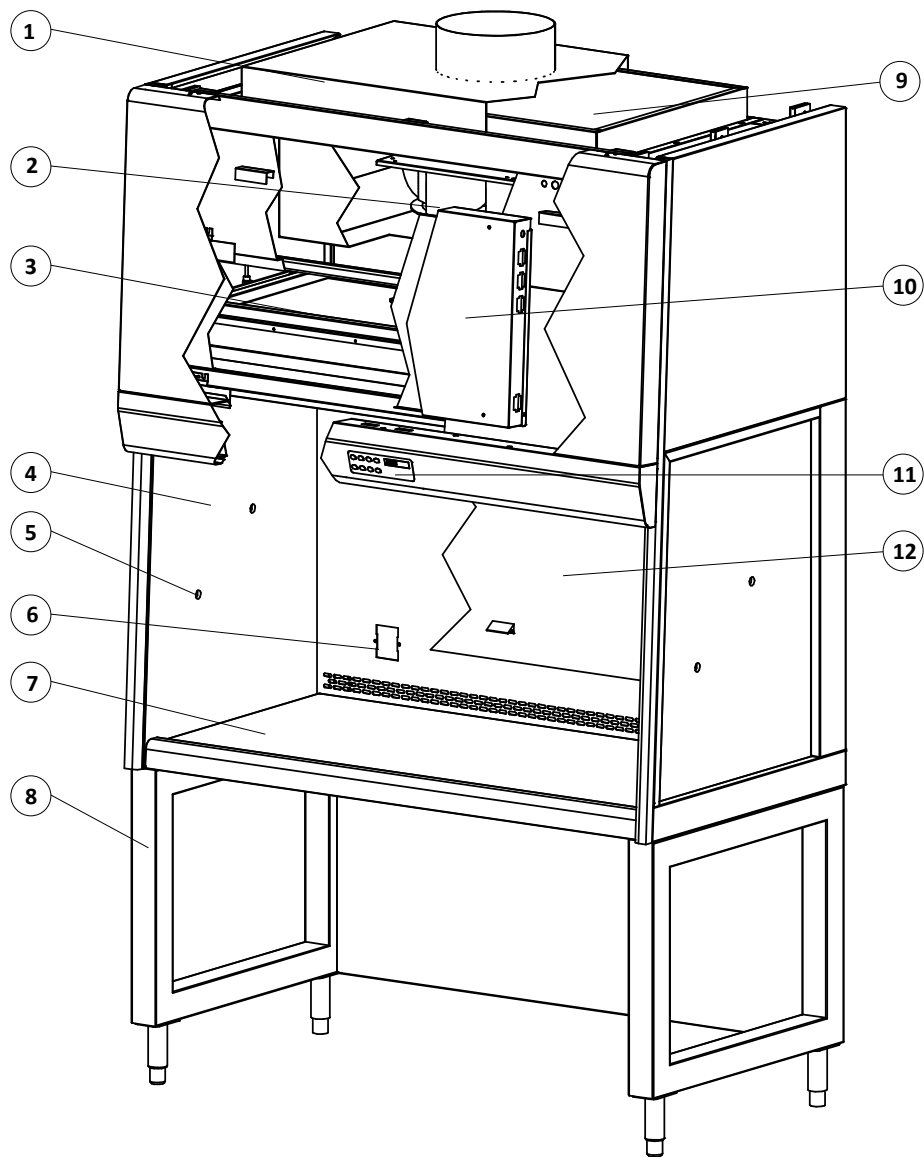

- | | |
|---|---|
| 1. Exhaust Collar (optional) | 8. Support Stand (optional) |
| 2. Blower | 9. Backup Carbon (C Series) Filter or
HEPA (E Series) Filter |
| 3. Carbon Filter(s) | 10. Electrical/Electronic Panel |
| 4. Tempered Glass Side Wall | 11. Esco Sentinel Microprocessor Control |
| 5. Service Fixture Provision (optional) | 12. Tempered Glass Sliding Sash Window |
| 6. Electric Outlet Provision (optional) | |
| 7. Stainless Steel Worktop | |

1.2 Filtracheck

FiltraCheck is a trademark service provided by Esco's fume filtration division. Customers who intend to purchase a ductless fume hood but are unsure whether the cabinet is suitable for their application, can forward a list of chemicals that they will be handling and their pattern of usage to Esco's FiltraCheck service team.

A PDF Questionnaire form is available at <http://ductless.escoglobal.com/>. This questionnaire can be downloaded and either forwarded by email or by fax to Esco. After careful analysis of the provided chemicals list and pattern of usage, a proper advice document will be generated and provided to the customer in 3 days period.

This document will recommend the appropriate laboratory equipment; ducted fume hood or ductless fume hood or neither based on the investigation done by the FiltraCheck team. Depending on the type of chemicals used, the document may also contain a list of procedures, warnings, etc. that will help in ensuring a safer laboratory working environment. In the case of a recommendation of a ductless cabinet, appropriate grade and type of activated carbon also becomes a factor that has to be taken into consideration.

Chapter 2 - Control System

2.1 Sentinel Control System

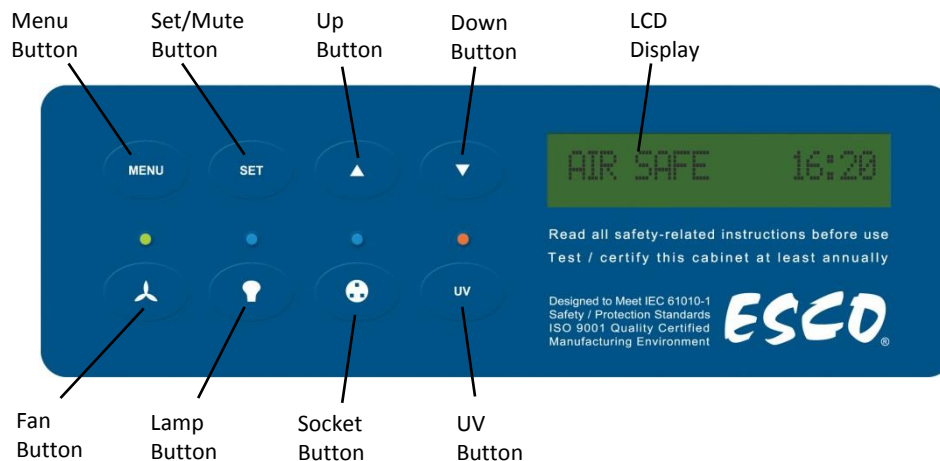

1. Fan Button
 - Turns on and turn off the fan.
2. Lamp Button
 - Turns on and turn off the lamp.
3. Socket Button
 - Turns on and turn off the electrical socket (retrofit kit).
 - The maximum rating of all the outlets in the cabinet is 5 A. if overloaded, the fuse will blow.
4. UV Button
 - Although present, this feature is not applicable.
5. Up (▲) and Down (▼) Arrow Button
 - Move upwards and downwards the menu options.
 - Increase and decrease corresponding value inside one of the menu options.
 - Move the sash window upward and downward (for motorized sash hood).
6. Set or Mute Button
 - Choose the menu or sub-menu currently displayed on the LCD screen.
 - Proceed to the next step or sequence inside one of the menu options.
 - Sash alarm can be muted by pressing Set button.
7. Menu Button

Alarm is disabled when you enter menu options

- To enter and exit from the menu options.
- To go back to the previous level of the menu options.
- To access maintenance mode from "AIRFAIL!" error condition.

2.2 Menu Options

When you are entering menu options, the alarm will sound to indicate that the microprocessor is not monitoring the operation of the hood and as such will not give airflow alarms. No further warnings will be given. Therefore, it is highly recommended that the user set the ADMIN PIN, which will restrict unauthorized access to the menu. The default ADMIN PIN from the factory is 0009.

Please refer to the following diagram for complete reference to all menu options available.

Press MENU button and enter the ADMIN PIN to enter the menu.

In the menu options:

- Press UP or DOWN button to move through the menu options.
- Press SET button to choose and proceed to the next step.
- Press MENU button to cancel and return to the previous step.

Exit menu options after making any changes in order to prevent unauthorized access to the menu.

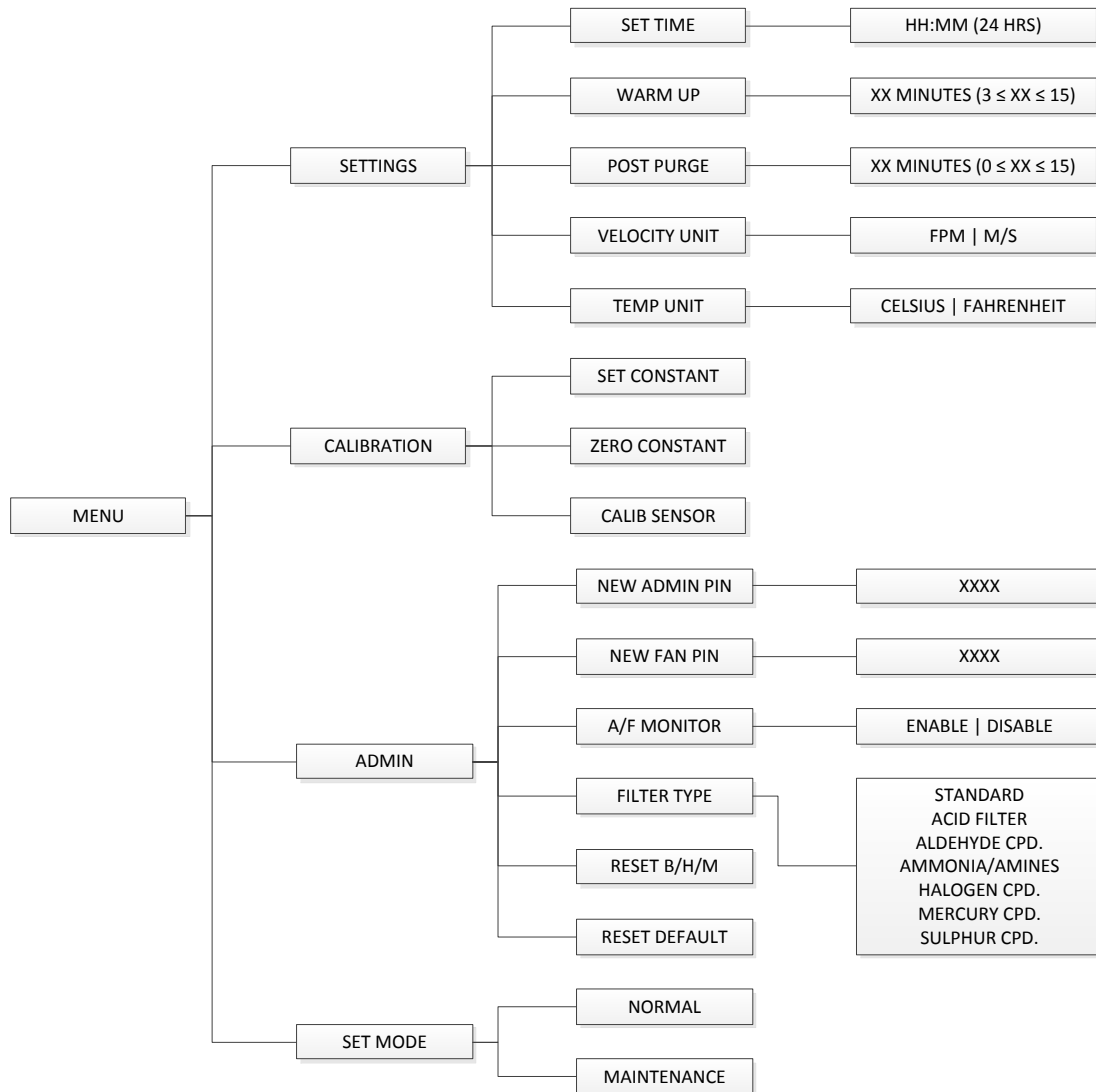

2.2.1 Settings

The user may use the settings menu function to customize the operation of the BSC to meet specific application requirements.

2.2.1.1 Set Time

Users can set the time by increasing/decreasing the hour and minute values. The correct time will be maintained even after the unit is turned off.



2.2.1.2 Warm Up

There will be a period of warm-up, before the fan is fully functioning. This is to ensure that the sensors, the blower, and the control system are stabilized, as well as purging the work zone of contaminants. The default setting is 3 minutes and the user can set it between 3 to 15 minutes.



2.2.1.3 Post Purge

After the user switches off the hood’s fan, there will be a post-purge period. This feature is to ensure that all residual contaminants are purged from the work zone. The default setting is 0 minute and user can set it between 0 to 15 minutes. Setting it to 0 minute will disable this feature. However, it is recommended to purge the fume hood by leaving the fan on for around 3 minutes after the work is complete.



2.2.1.4 Velocity Unit

Using this option, the user can select the unit in which air velocity is measured and displayed.

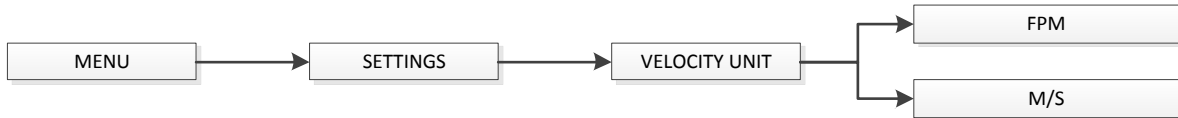

2.2.1.5 Temperature Unit

Using this option, the user can select the unit in which air velocity is measured and displayed.

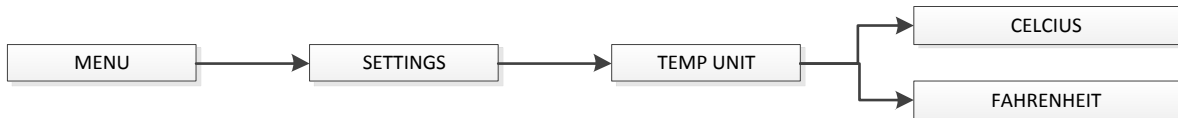

2.2.2 Calibration

The purpose of calibration is to ensure the accuracy of the airflow display and alarm (if present). This involves measuring airflow with reference instrumentation and establishing reference between airflow sensor(s) on the hood to the standard reference. Calibration should only be carried out by trained personnel. This section is presents a brief overview of the calibration menu function. For more information, refer to test report.

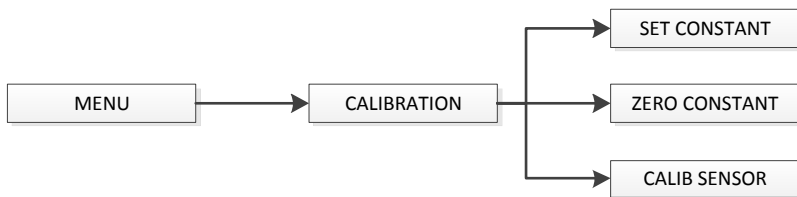

2.2.2.1 Set Constant

Every sensor manufactured by Esco has a specific Sensor Constant which is used for temperature compensation performed by the temperature sensor.

2.2.2.2 Zero Sensor

This option let the controller record the specific sensor output voltage and correspond it to 0 m/s or 0 fpm.

2.2.2.3 Calib Sensor

This option allows proper calibration and operation of the airflow sensor alarm. There will be three points to be calibrated, namely inflow fail point, inflow nominal point, and downflow nominal point.

2.2.3 Admin

The admin menu allows you to change both fan and Admin. PIN, also to disable it (not recommended). The reset blower hour meter is usually used after you change the blower (or filter) and it can easily give you the indication on when to do maintenance. While the reset default function will return the options in the settings menu to their factory settings.

2.2.3.1 New Admin. PIN

ADMIN PIN restricts access to MENU functions, including service functions, like calibration. User must enter four digits PIN before accessing MENU. ADMIN PIN has higher priority and can be used to control the fan (override Fan PIN).

ADMIN PIN can also be used to switch to maintenance mode from ERR.MSWITCH and AIR FAIL! errors condition.

The default PIN is 0009. Setting PIN to 0000 will disable this feature.



2.2.3.2 New Fan PIN

Fan PIN restricts access to fan control. User must enter four-digit PIN before switching fan on or off. As such, it can restrict access to operating the hood by unauthorized personnel. Fan PIN is also needed to disable the alarm when the sash is fully raised and cleaning needs to be performed.

It is recommended that the Fan PIN be issued only to personnel authorized to use the hood.

The default PIN is 0001. Setting the PIN to 0000 will disable this feature.



2.2.3.3 A/F Monitor

Whenever the air velocity falls below the fail point, the air fail alarm will be triggered. This option is used to enable/disable alarm.

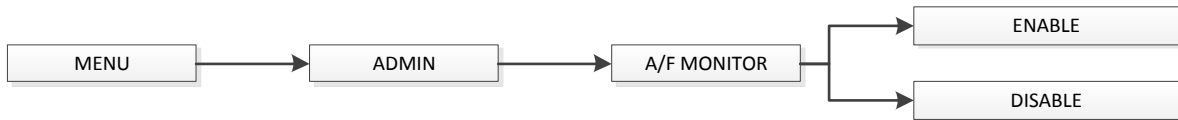

2.2.3.4 Filter Type

To set the type of main carbon filter(s) used in the hood. The options include standard, acid filter, aldehyde compound, ammonia/amines, halogen compound, mercury compound and sulphur compound.

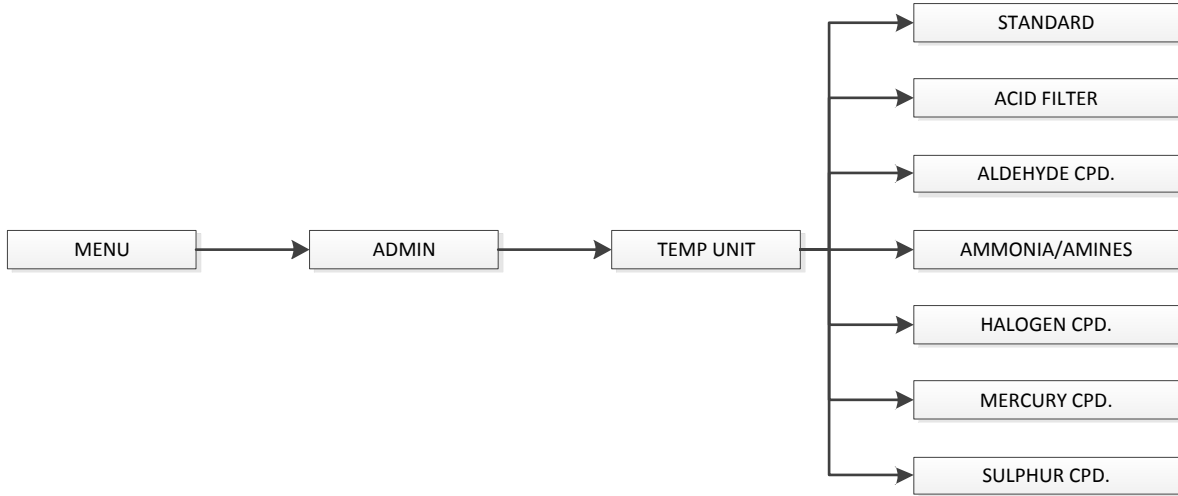

2.2.3.5 Reset Blower Hour Meter

This option is used to reset the blower hour meter. The blower hour meter indicates how long the blower has been in operation. Maximum counter is set at 9999 hours. The counter value can be checked while in maintenance mode. The value can also provide some help in setting up maintenance schedule, including filter change.

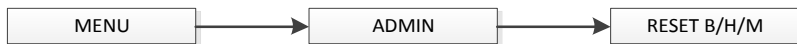

2.2.3.6 Reset Default

User can reset the default setting by choosing this option. The features being reset are warm-up period (3 minutes), post-purge period (0 minute), velocity unit (Metric), temperature unit (Celsius), Admin. PIN (0009), and Fan PIN (0001).

Note that the calibration settings cannot be reset as it may cause the BSC to operate in an unsafe manner. The hour meters cannot be reset either.

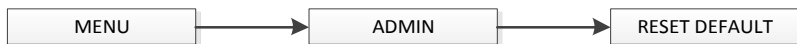

2.2.4 Setting Mode

Ductless fume hood has two working mode, the default normal mode which is used in a day to day activity, and maintenance mode.



2.2.4.1 Normal Mode

Every time the hood is restarted, this mode will be activated by default. In this mode, all alarms and interlocks are enabled.

2.2.4.2 Maintenance Mode

Maintenance mode should only be accessed by qualified personnel during maintenance. In this mode, all alarms are disabled and all interlocks are defeated.

2.3 Alarm and Warnings

The warning AIR FAIL! indicates that there is airflow failure. The operator should check if there is any obstruction to the airflow, and correct it if possible. However, if the problem continues, the operator should stop working as the hood's protection may have been compromised. Call service or Esco's local distributor.

Other alarms that indicate a failure or an error in the BSC system:

- ERR.AIRFAIL will be displayed if the blower is turned off while there is an airflow failure.
- ERR.CALIB will be displayed if the airflow velocity sensor is not yet calibrated.

Chapter 3 – Basic Hood Operation

3.1 Sash Window Operation

3.1.1 Sash Window State

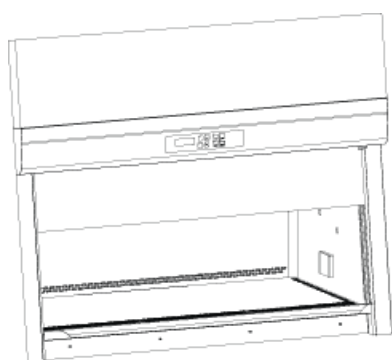

Sash is fully open

- ✓ Blower can be active
- ✓ Fluorescent lights can be used
- ✗ Unsafe working condition

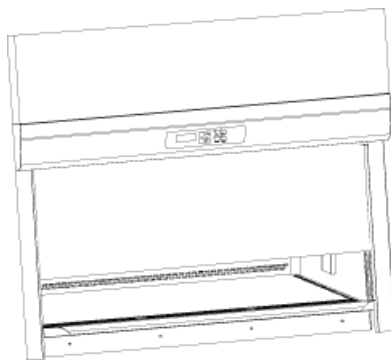

Sash is in safe position

- ✓ Blower can be activated
- ✓ Fluorescent lights can be used
- ✓ Safe working condition

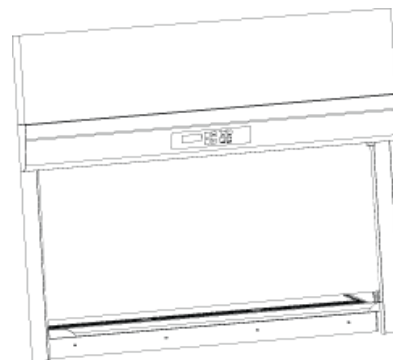

Sash is fully closed

- ✗ Blower can't be activated
- ✗ Fluorescent lights can't be used

3.1.2 Operating Motorized Sash Window (Only for hoods with motorized sash window)

The motorized sash uses a “push and hold” mechanism, so if you remove your finger from the button the sash will stop immediately – this is a safety feature to control the closure and prevent anything getting trapped in the aperture as the sash descends.

Lower Sash from Fully Open Position

When the sash is fully open, pressing the down button and holding it will cause the sash to move to the Safe Height setting and stop. If the fluorescent lights are on as the sash descends, they will stay on as long as the sash stops in the Safe Position. If you release the button before the sash has reached Safe Position the lights will switch off automatically.

Lower Sash from Safe Height Position

When the sash is at safe operating height pressing the down button and holding it will cause the sash to move down to the fully closed position and stop. If the fluorescent lights are on as the sash descends, they will switch off automatically as soon as the sash reaches fully closed. If you release the button before the sash has reached the fully closed position the lights will switch off automatically.

Raise Sash from Fully Closed Position

When the sash is fully closed, pressing the up button and holding it will prompt the user to input the password to turn on the fan. If the password is correct, if it was on fan will turn on and the sash will move up to the Safe Height setting and stop.

Raise Sash from Safe Height Position

When the sash is safe operation position, pressing the up button and holding it will cause the sash to move up to the fully open position and stop. If the fluorescent lights are on as the sash rises, they will stay on as long as the sash is allowed to fully open. Stopping the sash midway will cause the lights to switch off automatically.

3.1.3 Using Sash Window

- The sash window should be fully closed when the hood is not in use. This helps keep the work zone interior clean.
- The sash window should always be in the normal operating height at all times when the hood is in use. Even if the cabinet is left unattended, but the blower is on, the sash window should never be moved from the normal operating height, unless during loading or unloading of materials/apparatus into the hood.
- The alarm will be activated whenever the sash window is moved from the normal operating height.
- Whenever the sash window is moved to the correct height from a higher or lower position, the light will automatically be turned on as a signal to the user.
- The sash window may be opened to its maximum position for the purpose of loading/unloading of materials/apparatus into the hood. When the sash window is fully opened, the alarm sound may be muted by pressing MUTE button but, will be automatically sounded again after 5 minutes to remind the user that it is not safe to work in the cabinet and the light will be turned on to facilitate cleaning.

3.2 Starting and Shutting Down the Ductless Fume Hood

3.2.1 Turning on the Hood

1. Raise the sash to the indicated normal operational height (READY state). The lamp will turned on when this height is reached.
2. Turn on the fan by pressing the FAN button. Input the Fan PIN if asked (default: 0001). This will start the warm up procedure (default: 3 minutes). All buttons are disabled during warm up period.
3. The hood is ready for work.

3.2.2 Turning off the Hood

1. Turn off the fan by pressing the FAN button. Input the Fan PIN if asked (default: 0001). This will start the post purge procedure (default: 0 minute). All buttons are disabled during post purge period.
2. Lower the sash to the fully closed position. The sash can be lowered immediately after turning off the fan as it will not interrupt the post purge procedure.

3.3 Operating the Ductless Fume Hood

3.3.1 Working in the Hood

- Check the label on the ductless fume hood to see what chemicals the hood is intended for – and only use the hood for any procedure involving such chemicals.
- Ensure the exhaust is operating before commencing work.
- After all the apparatuses/items have been arranged, allow the blower to run for another 3 minutes in order to purge work zone of contaminants.
- Minimize room activity since these external airflow disturbances may adversely affect the hood's internal airflow, impairing the containment capabilities of the fume hood.
- Keep your head outside of the hood.
- Work as far into the hood as possible and with slow, deliberate movements, to minimize airflow disturbances.
- Work with the sash as fully lowered as possible, utilizing the sash as a natural barrier.
- Do not use this hood as a storage area. Items can block airflow and interfere with containment.
- If performance is suspected, or an airflow alarm is triggered (*if installed*), terminate usage, close the sash completely, and cease work.
- Do not let organic chemicals evaporate in the hood – use a proper waste bottle. Do not leave uncapped bottles of chemicals or waste in a hood.
- Certify this hood annually to verify airflow velocity, smoke patterns and containment.
- Perform routine maintenance in accordance with the manufacturer's instructions.

3.3.2 Working Ergonomics

On most occasions, you would most likely be operating the fume hood in sitting rather than standing posture.

There are some obvious advantages of the sitting posture:

- The physiological energy cost and fatigue involved in sitting are relatively less
- Sitting posture provides the body with a stable support

However, sitting position has some drawbacks too:

- The working area available is fairly limited
- There is a potential risk of being constrained in the same posture for a long time
- Sitting posture is one of the most stressful postures for one's back

Therefore you should pay careful attention to the following guidelines in order to achieve comfortable and healthy working conditions:

1. Always ensure that your legs have enough legroom.
2. Keep your lower back comfortably supported by your chair. Adjust the chair or use a pillow behind your back whenever necessary.
3. You should place your feet flat on the floor or on a footrest. Don't dangle your feet and compress your thighs.
4. You should keep varying your sitting position throughout the day at regular intervals so that you are never in the same posture for too long.
5. Observe the following precautions with respect to your eyes:
 - Give your eyes frequent breaks. Periodically look away from the work area and focus at a distant point.
 - Keep your glasses clean.
6. Arrange the items/apparatus frequently used in your work in such a way that you can minimize the physical strain involved in handling them.
7. Exercise regularly

Ergonomics accessories available with Esco include:

- a. Armrest padding
- b. Lab chair
- c. Footrest

Please contact your local distributor or Esco for more information.

Chapter 4 – Maintenance

4.1 Scheduled Maintenance

Proper and timely maintenance is crucial for trouble free functioning of any device and your Esco ductless fume hood is no exception to this rule. We strongly recommend that you follow the maintenance schedule suggested hereunder in order to obtain optimal performance from your Esco ductless fume hood.

No.	Description of Task to Perform	Maintenance to be carried out every				
		Week	Month	Quarter	1 Year	2 Years
1	Check the alarm and measure the basic airflow	√				
2	Clean the interior work surface and walls with soap water	√				
3	Wipe down sash with appropriate glass cleaner	√				
4	Clean the exterior surfaces of the ductless fume hood		√			
5	Measure the ductless fume hood face velocity		√			
6	Check fans, motors, drives and bearings for proper operation			√		
7	Check fluorescent tubes for proper operation			√		
8	Test the operation of airflow alarm			√		
9	Repair defect and lubricate as necessary			√		
10	Clean the stainless steel surface using MEK			√		
11	Re-certification				√	
12	Change the fluorescent lamps					√
13	Check filter saturation	(check according to Filtrachek recommendation)				

Cleaning the Hood

- Clean the work surface and walls with soap water
- Clean the sash window using an appropriate glass cleaner
- Use a damp cloth to clean the exterior surface of the fume hood, particularly on the front and top in order to remove dust that accumulated there
- Use clean water to finish the cleaning and wash away any residue from the soap water and glass cleaner
- For removing stubborn stains or spots on the stainless steel surface, make use of MEK (Methyl-Ethyl-Ketone). In such cases, make sure that you wash the steel surface immediately afterwards with clean water and some liquid detergent. Use a polyurethane cloth or sponge for washing. Regularly cleaning the stainless steel surface can help you retain the attractive factory finish.

Test the audible and visual alarm

If possible, cover the airflow sensor; otherwise cover the perforations on the back wall – this should disrupt the airflow of the hood enough to activate the alarm

Check the hoods functionality

- Check the hood's mechanical functionality; ex: sash window – lubricate if necessary
- Check the hood's electrical functionality; ex: fluorescent lamp – replace if necessary
- Check the hood for any defect, repair immediately

Check filter saturation

Check for filter saturation often. The saturation level of a filter is directly affected by the amount of chemical fume generated by the experiment conducted inside the fume hood. Use particle counter below and above the main (and backup) filter and compare the results to check the saturation level of the carbon filter.

Re-certification

All ductless fume hoods must be re-certified annually by a certified engineer.

4.2 Maintenance/Service Log

It is good practice (and in some cases regulatory requirement) to maintain a log of all maintenance work carried out on your freezer.

APPENDIX

